

Look Up . . . to **SHEN-O-DECK**

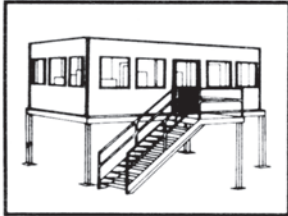

ELEVATED OFFICES

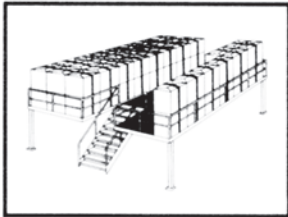

RAISED STORAGE

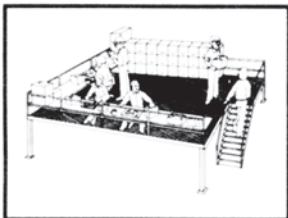

ADDITIONAL
PRODUCTION

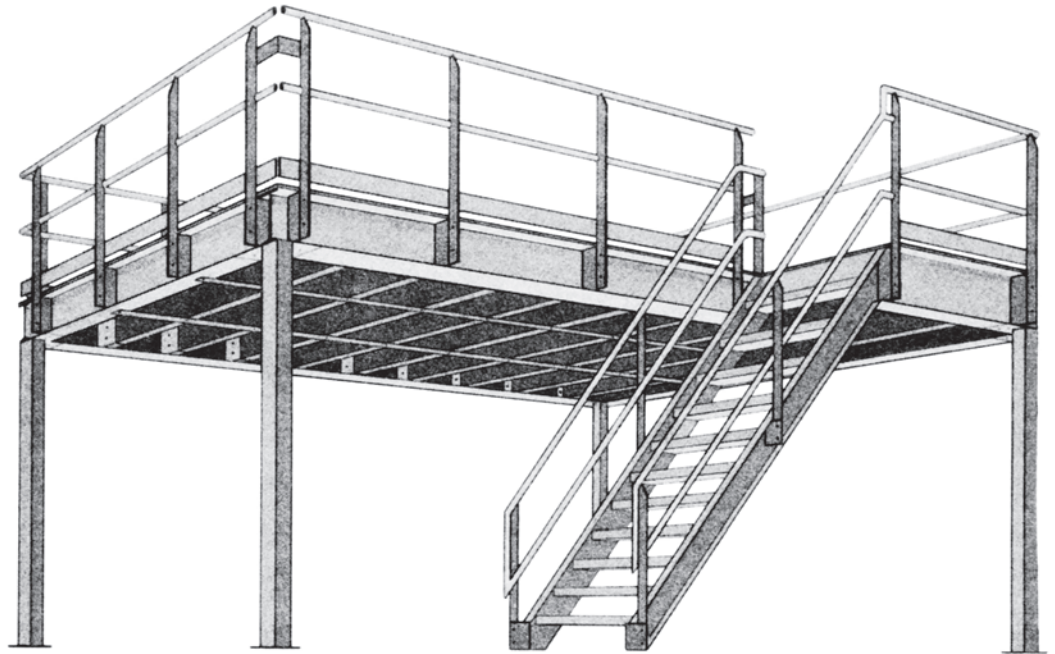

Utilize the space you already own by moving up—instead of out. The economics are simple. Overhead space is heated, well lighted and in most cases, wasted. SHEN-O-DECK allows you to convert overhead space to productive floor space for a fraction of the cost of new construction or signing a lease.

FEATURES

- SHEN-O-DECK is constructed of steel
- Exclusive "J-Bracket" assembly allows faster installations
- Structural steel beams and columns are used for maximum strength and resistance to impact damage.
- Floor joints are constructed of lighter, rolled "C" sections for long span capabilities.
- Simple design
- On-site installation is fast and easy.
- Custom engineered to your specific requirements

- No welding is required.
- SHEN-O-DECK is 100% relocatable for maximum utilization.

ADVANTAGES

- Uses overhead space instead of valuable floor space.
- Meets National Building and Safety Codes.
- Local representatives and design assistance.
- Fast fabrication and delivery.
- Complete erection drawings provided.

Components... Built to Last

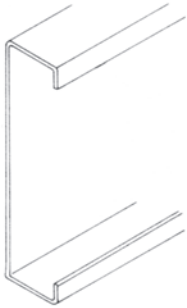

Floor Joist—is rolled "C"-section for long-span floor capabilities and lowest weight/cost ratio.

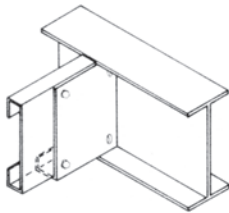

Exclusive "J" Bracket—provides a positive, simple yet structurally superior connection of floor joists to perimeter beams.

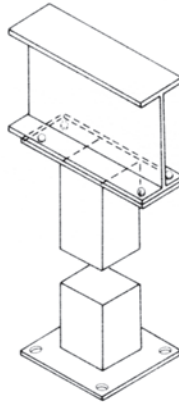
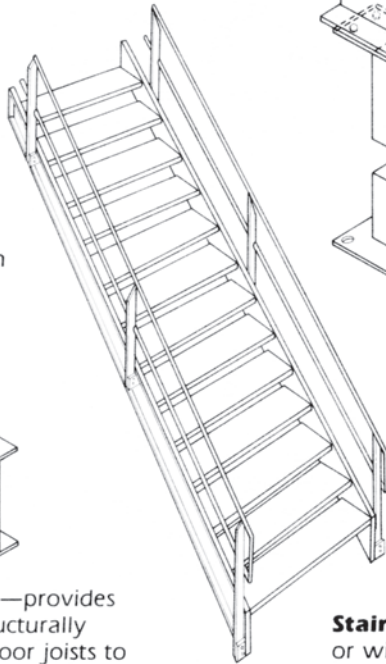

Free Standing Column—square tube, structural steel for maximum load ability and resistance to impact damage.

Swing Gates—allow loading on second level with fork lift trucks.

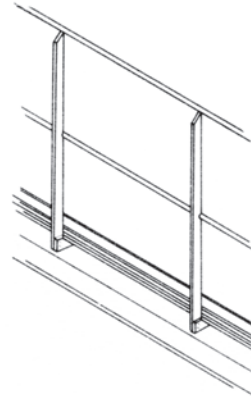
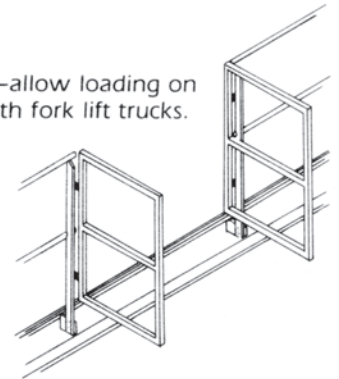

Handrail—exceeds National Safety Codes

SHEN-O-DECK DECKING

Three types of decking are available to suit virtually any application. Each design offers a variety of features and can be engineered to the specific load requirements of your SHEN-O-DECK installation.

Mechanical Connections

Unlike other mezzanine systems which rely on tek screws at critical load points, only high strength nuts and bolts are used in connecting SHEN-O-DECK beams, columns and floor joists. Tek screws are used strictly as a removable method of SHEN-O-DECK deck attachment.

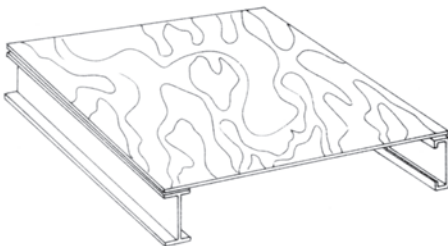

PLYWOOD

Fire treated, tongue and groove plywood is by far the most economical yet offers the greatest uniform load capability.

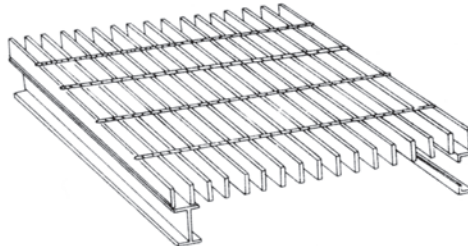

STEEL BAR GRATING

With over 80% open floor surface this deck material allows maximum ventilation and light and in most cases eliminates the need for lower level sprinkler systems.

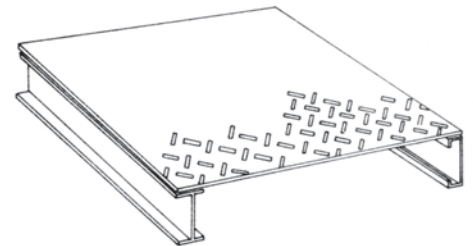

STEEL FLOOR PLATE

Non-skid steel floor plate will withstand years of punishment and provides a surface suitable for push carts, hand trucks and casters.



307 Carbaugh Street, P.O. Box 268
West Middlesex, PA 16159-0268 U.S.A.
Telephone: (412) 528-9925
1-800-548-0625 U.S. FAX: 1-412-528-9920
1-800-548-0626 PA